

INSPECTION CERTIFICATE

It is hereby certified that this product was manufactured under our single unit quality control system and has passed strict inspection in accordance with our electric chain hoist inspection standard.

Item No.	HHXG H-1000-1
Product	Electric Chain Hoist
Rated Load	1000 Lbs
Test Load	1250 Lbs
Lift	15 Feet
Lifting Speed	17 Feet /min
Rated Vol.	110V/220 V
Frequency	60 Hz
E.D.	40 %
Ins. Class	F class
Serial No.	17010044

Date: Dec. 12, 2017

Inspector: 02

HHXG ILLUSTRATION FOR WIRE CONNECTION OF SINGLE-PHASE(110V/220V) MOTOR

110V

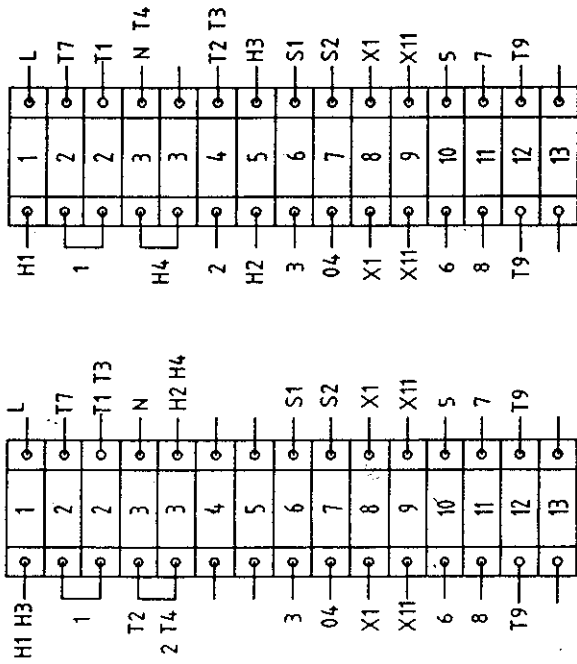

220V

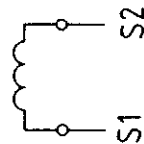
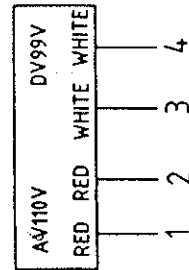
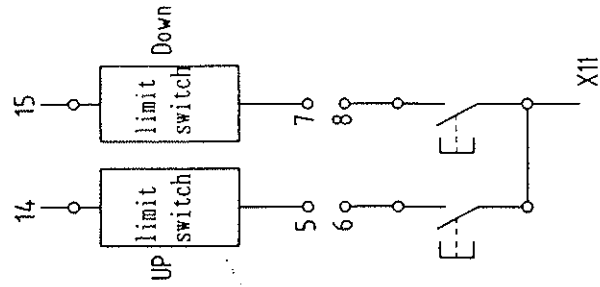
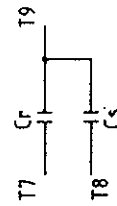
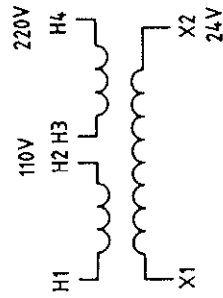
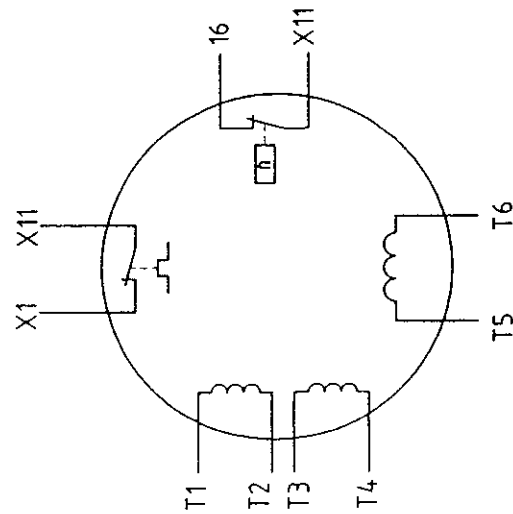
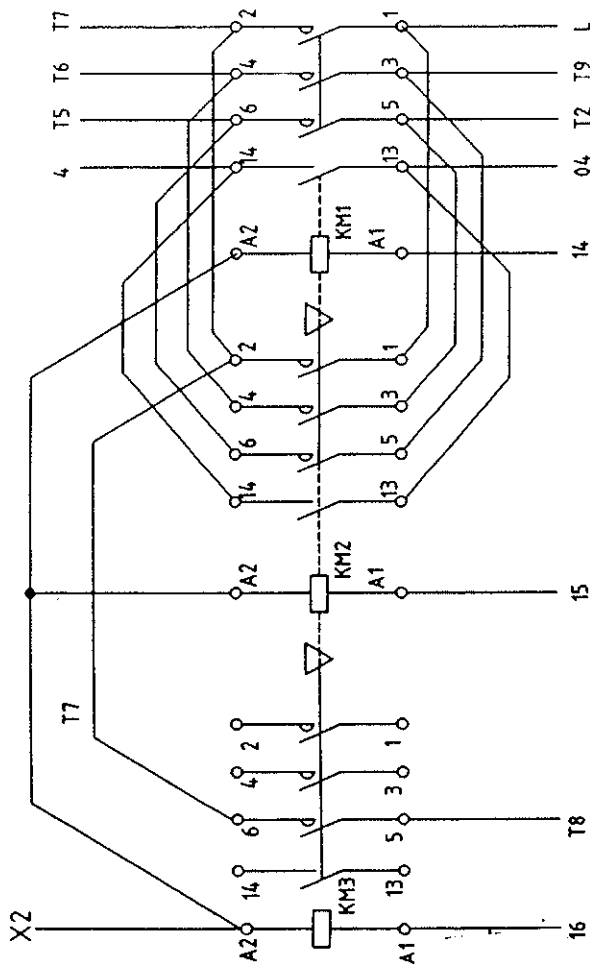
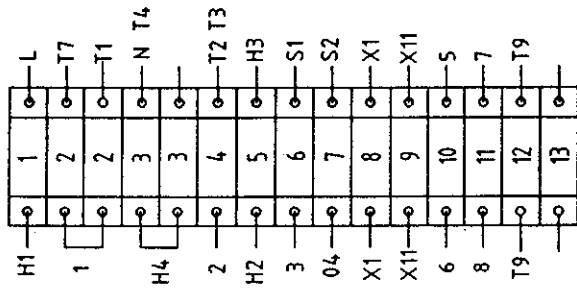

INSTRUCTIONS FOR HANDLING ELECTRIC CHAIN HOIST

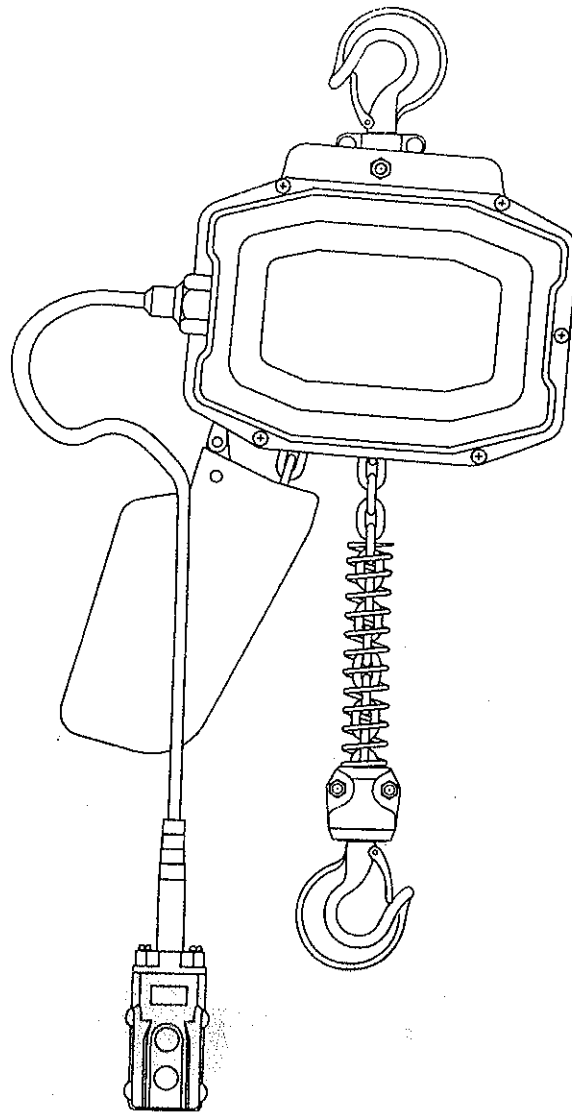

CAUTION - IMPORTANT

Before hoist use, all persons who will install, operate or maintain should read this manual thoroughly. For safe, dependable and economical performance, follow all instructions and recommendations contained herein. When use hoist in the manner other than those stated in this manual, please contact the nearest representative. It is also important to retain this manual for future use.

WARNING

THIS HOIST IS INTENDED FOR INDUSTRIAL USE ONLY AND SHOULD NOT BE USED TO LIFT, SUPPORT OR OTHERWISE TRANSPORT HUMAN CARGO.

TABLE OF CONTENTS

1. SAFE OPERATING PRACTICE.....	1
2 GENERAL INFORMATION.....	2
3. INSTALLATION.....	5
4. OPERATION.....	6
5. MAINTENANCE.....	8
6. TROUBLE SHOOTING.....	11
7. DISASSEMBLE AND REASSEMBLY.....	13
8. LIST OF REPAIR PARTS.....	14

1. SAFE OPERATING PRACTICE

The following are recommendations for safe operation of over head hoist.

Failure to heed the following recommendations could endanger the operator and others.

Use good common sense at all time.

Safety is the responsibility of the operator of the equipment.

You must be competent and attempt to foresee and avoid all hazardous conditions.

To be safe as possible, the hoist must be given proper preventive, periodic inspection and maintenance as described in this manual.

1. Do not operate hoist unless you are properly trained, physically fit, and authorized to do so.
2. Do not operate hoist unless you are familiar with all controls, warning and instructions on or attached to the hoist, safe operating listed in this bulletin before starting operation.
3. Do not allow any unqualified personnel to operate hoist.
4. Never pick up a load beyond the rated capacity appearing on the hoist.
5. Never carry personnel on the hook or the load.
6. Never lift a load with the hoist until all personnel are clear.
7. Never use the chain as a sling.
8. Do operate the hoist apart from the load suspended.
9. Do not try to lift fixed or obstructed loads.
10. Do not transport load over personnel.
11. Do not use the chain as a ground for welding.
12. Never touch a welding electrode to the chain.
13. Do not leave a load suspended in the air for extended or unattended periods.
14. Keep watching the load while operating the hoist.
15. Center hoist unit over the load before lifting. Avoid side pull and end pull.
16. Be sure the sling is properly seated in the saddle of the hook.
17. Make sure a load clears neighboring stock piles of machinery before moving.
18. Avoid plugging, excessive inching, and quick reversals of load.
19. Avoid swinging of load or load hook when traveling the hoist.
20. Check limit devices and braking mechanism daily for proper function Check daily the chain for improper seating, twisting, kinking, wear, or other defects before the hoist.
21. Be sure that the power supply is disconnected before performing maintenance and repair procedure.
22. Do not operate hoist if it is functioning improperly.
23. Do not use the limit switch as a means of stopping the loaded hook in the down direction. This is primarily a backup device.
24. Do not use hoist in the manner not described in this manual.
25. Perform all daily, monthly and yeary inspections as indicated.
26. Do not remodel the hoist.
27. Do not use hoist in the manner to restrict a free action of lifting, such as material cargo guided by rails for example.
28. Do not use the hoist where it is exposed to rain or water.

When the hoist mechanism has reached the end of theoretical duration of service please have qualified technicians to check the wearing of parts and components such as motor, gearbox, brake, limiter, hook, stand etc. Parts under severe abrasion must be set to replacement.

2 GENERAL INFORMATION

2.1 Dimension & Specifications

MODEL HHXG2 SUSPENDED TYPE SINGLE PHASE ELECTRIC CHAIN HOIST

Item Number	Rated load (ton)	Lift (m)	Lifting speed (m/min)	Hoist Output(kw)	Motor 1-phase Ins class	Motor 1-phase % ED	Lood chain Dia mm	Chain Number of falls	Test Load ton	Min Headroom Max (mm)	Net Weight (kg)
HHXG205	0.5	3	5.2	0.8	F 40	40	7.1	1	0.625	545	64
HHXG210	1	3	5.2	1.2	F 40	40	7.1	1	1.25	580	65
HHXG220	2	3	2.6	1.2	F 40	40	7.1	2	2.5	740	72
HHXG230	3	3	1.7	1.2	F 40	40	7.1	3	3.75	790	80
HHXG250	5	3	1.0	1.2	F 40	40	7.1	5	6.25	880	92

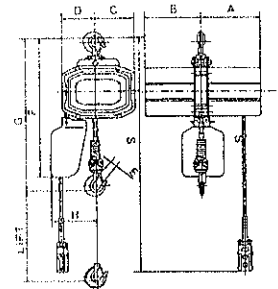

0.5T, 1T

Item Number	Rated load (ton)	Lift (m)	Major Dimensions (approx) (mm)						
			A	B	C	D	E	F	H
HHXG205	0.5	3	249	249	168	146	25	565	195
HHXG210	1	3	249	249	168	146	30	614	195
HHXG220	2	3	249	249	180	134	33	665	235
HHXG230	3	3	249	249	100	214	41	720	270
HHXG250	5	3	249	249	100	284	52	740	334

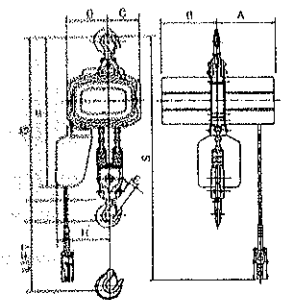

2T

MODEL HHXG3 SUSPENDED TYPE THREE PHASE ELECTRIC CHAIN HOIST

Item Number	Rated load (ton)	Lift (m)	Lifting speed (m/min)	Hoist Output(kw)	Motor 3-phase Ins class	Motor 3-phase % ED	Lood chain Dia mm	Chain Number of falls	Test Load ton	Min Headroom Max (mm)	Net Weight (kg)
HHXG305	0.5	3	6.3	0.8	F 40	40	7.1	1	0.625	545	64
HHXG310	1	3	5.2	1.6	F 40	40	7.1	1	1.25	580	65
HHXG320	2	3	3.2	1.6	F 40	40	7.1	2	2.5	740	72
HHXG330	3	3	1.6	1.6	F 40	40	7.1	3	3.75	790	80
HHXG350	5	3	1.2	1.6	F 40	40	7.1	5	6.25	880	92

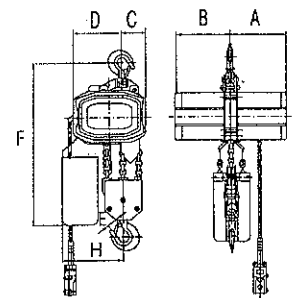

3T

Item Number	Rated load (ton)	Lift (m)	Major Dimensions (approx) (mm)						
			A	B	C	D	E	F	H
HHXG205	0.5	3	249	249	168	146	25	565	195
HHXG210	1	3	249	249	168	146	30	614	195
HHXG220	2	3	249	249	180	134	33	665	235
HHXG230	3	3	249	249	100	214	41	720	270
HHXG250	5	3	249	249	100	284	52	740	334

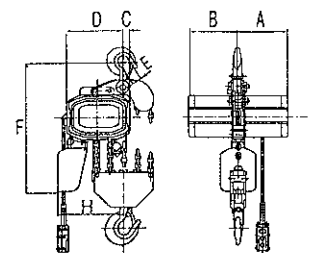

5T

(1) Explanation to Theoretical total duration of mechanisms

You can refer to below table for the safety operation the product in consideration of the group of mechanism.

*** Group classification of a mechanism as a whole**

State of loading	Nominal load spectrum factor K_m	Class of utilization of mechanisms									
		T0	T1	T2	T3	T4	T5	T6	T7	T8	T9
L1 - Light	0.125			M1	M2	M3	M4	M5	M6	M7	M8
L2 - Moderate	0.25		M1	M2	M3	M4	M5	M6	M7	M8	
L3 - Heavy	0.5	M1	M2	M3	M4	M5	M6	M7	M8		
L4 - Very heavy	1.00	M2	M3	M4	M5	M6	M7	M8			

*** Nominal load spectrum factor for mechanism, K_m**

State of loading	Nominal load spectrum factor K_m	Remarks
L1 - Light	0.125	Mechanisms subjected very rarely to the maximum load and, normally, to light loads
L2 - Moderate	0.25	Mechanisms subjected fairly frequently to the maximum load but, normally, to rather moderate loads
L3 - Heavy	0.5	Mechanisms subjected frequently to the maximum load and, normally, to loads of heavy magnitude
L4 - Very heavy	1.00	Mechanisms subjected regularly to the maximum load

*** Class of utilization of mechanism**

Class of utilization	Total duration of use (h)	Remarks
T0	200	Irregular use
T1	400	
T2	800	
T3	1600	
T4	3200	Regular light use
T5	6300	Regular intermittent use
T6	12500	Irregular intensive use
T7	25000	Intensive use
T8	50000	
T9	100000	

When the hoist mechanism has reached the end of theoretical duration of service please have qualified technicians to check the wearing of parts and components such as motor, gearbox, brake, limiter, hook, stand etc. Parts under severe abrasion must be set to replacement.

2.2 Application Information

This hoist is intended for general industrial use in the lifting and transporting of freely suspended material loads within its rated capacity. Prior to installation and operation, we caution the user to review his application for abnormal environmental or handling conditions and to observe the applicable recommendations as follows:

CAUTION

Do not use the hoist for transporting hot molten masses.

Do not use the hoist in explosion hazard areas.

Do not use the hoist in aggressive environments and outdoors.

Do not use the hoist at low temperature below 0 °C or high temperature over 40 °C.

- a. **Adverse Environmental Conditions** Do not use the hoist in areas containing flammable vapors, liquids, gases or any combustible dusts or fibers. Do not use this hoist in highly corrosive, abrasive or wet environments. Do not use this hoist in applications involving extended exposure to ambient temperatures below 0 °C or high temperature over 40 °C. Do not use the hoist in the area of sea level over 1000 m. Do not use the hoist in the area with humidity over 85%.
- b. **Lifting of Hazardous Loads** This hoist is not recommended for use in lifting or transporting hazardous loads or materials which could cause wide-spread damage if dropped. The lifting of loads which could explode or create chemical or radioactive contamination if dropped, requires fail-safe redundant supporting devices which are not incorporated into this hoist.
- c. **Lifting of Guided Loads** This hoist is not recommended for use in the lifting of guided loads, including dumbwaiters and non-riding elevators. Such appliances require additional protective devices which are not incorporated into this hoist.

2.3 Repair Parts Ordering Information

To sure prompt service, place all parts orders with your local distributor. The following information must accompany all correspondence or replacement parts order.

1. Complete data from hoist nameplate.
(Type, Volt, Phase and Hertz)
2. Part No's, description and quantity required.
3. When ordering chain or chain container, give additional informations, lift of hoist and no of falls.
4. Correct shipping destination.

CAUTION

When replacement parts are needed, order only by Engineering Parts.

3. INSTALLATION

CAUTION

Make sure all supporting structures and attaching devices are strong enough to hold your intended loads. Installation area must provide proper operating conditions for the operator including sufficient room for the operator and other personnel to stand clear of the load at all times.

3.1 Electrical Installations

CAUTION

Before connecting power to the hoist, be sure the power supply corresponds to the hoist rating. Check the power supply within plus or minus 10% of rated voltage, and frequency with ± 1 Hz. This hoist should be used under the ambient temperature within $5-40^{\circ}\text{C}$, humidity within $50\%/40^{\circ}$, or $90\%/20^{\circ}\text{C}$, and installation altitude not beyond 1000m above sea level, For transport/storage, be care the temperature should not exceed the scope of $-25^{\circ}\text{C}-55^{\circ}\text{C}$.

It is essential to install an over voltage protection device against lightning in power supply system.

CAUTION

Do not rewire the push button.

3.2 Chain Container Installation

The Chain container used to house, the slack side of the load chain in order to ease operation, is installed on all standard lift models.

CAUTION

1. Do not extend lift of the hoist by yourself.
In case longer lift than standard is required, contact an authorized repair shop.
2. Do not use hoist without a chain container.

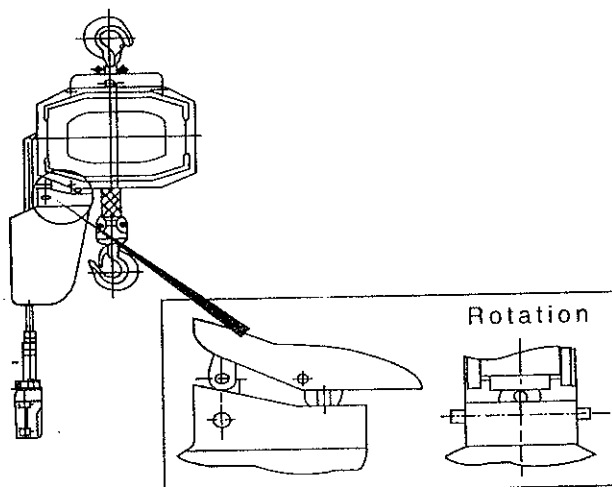

Figure 1

3.3 Function Testing

(a) Limit Switch Operation

Before placing the hoist in operation, check for proper operation of upper and lower limit switch. Push the UP (DOWN) button, while the hook is moving upward (downward) direction. The hoist should stop immediately.

CAUTION

Do not operate the hoist if the limit switch is not operating properly. Do not use the limit switch as a means of stopping the hook travel. This is primarily a backup device.

(b) Brake Operation

Check for load hook drift with rated load on the hook. If hook does not stop within 25mm when push button is released, it may be necessary to adjust or replace the brake assembly.

(c) Rated capacity limiter

The rated capacity limiter is designed for the safety operation. It is composed by brake, washer, butterfly spring, spring seat and adjusting nut. Designed capacity limitation between 1,3 WLL to 1,6 WLL is realized by adjusting nut. Adjusting the nut in clockwise to increase the capacity, while counter-clockwise to decrease the capacity.

Setting and checking capacity limiter:

1. When the hoist can not lift the load of 1,3 WLL, the rated capacity limiter shall be adjusted to increase the capacity;
2. When the hoist can still lift the load of 1.6 WLL, the rated capacity limiter shall be adjusted to decrease the capacity.

CAUTION

- For safe operation, the setting and checking of the rated capacity limiter shall be done according to the instructions of the manufacturer by competent persons only. He shall request from these competent persons to document the test result in the logbook.
- Because the hoist is not fitted with a rated capacity indicator the hoist shall be used only in those applications, for which the rated capacity does not vary with the position of the load.
- Forbidden use the rated capacity limit to check the overloading.

4. OPERATION

4.1 Good Operating Practices

1. The operator should not engage in any practice which will divert his attention while engaged in operating the hoist.
2. Before starting the hoist, the operator should be certain that all personnel are clear.
3. Pushbutton, brake and limit switch should be tested by the operator before beginning a shift. If these controls do not operate properly, they should be repaired or replaced before operations are started.

4.2 Handling the Load

CAUTION

Do not exceed the rated load.

(a) Attaching load

1. The hoist chain should not be wrapped around the load.
2. The load should be attached to the hook by means of slings or other appropriate devices which should be seated properly in the saddle of the hook before operation.
3. Operate hoist in a hanging position only. Hoist should be permitted to align itself for a straight line pull. Do not attempt to pull around corners.

(b) Moving the load

WARNING

Do not use the hoist for lifting people and avoid carrying loads over people.

1. Before starting to hoist, the chain should not be kinked or twisted.
2. The chain shall be tightened and shall not be in the slack condition when the load is being lifted from the ground.
3. The operator should inch the hoist into engagement with the load, and avoid unnecessary stops and starts.
4. The load should not be lifted more than a few inches until it is well balanced on a sling or lifting device.

4.3 Proper Slings for Safety Operation

One of serious hazards is dropping of the load caused by improper slinging. All operators of the hoist shall make sure before operations that the slings or other approved devices are seated properly in the saddle of the hook. Please do not neglect the following for your own safety and the safety of others.

PROPER SLINGING

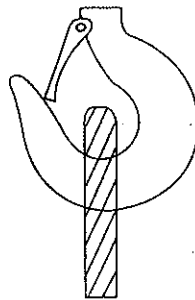
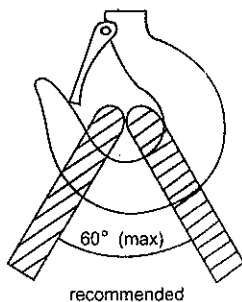

The safety latch shall be returned in the original position after slinging. The slings shall be seated properly in the saddle of the hook.

IMPROPER SLINGING

Belows are examples of misuse of the slings. You must recognize that the slings shall not touch the safety latch in any manner.

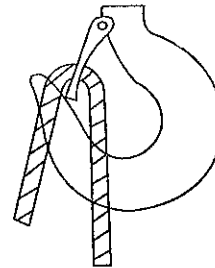
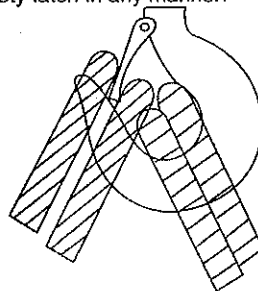
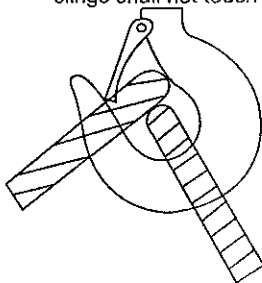

Figure 2

WARNING

1. The hook latch is for preventing the slings from coming off and not for loading.
2. Damaged or improperly working hook latch shall be replaced immediately for further use of the hoist.

5. MAINTENANCE

5.1 Preventive Maintenance Schedule

The periods between inspections will vary due to the wide range of duty cycle and operating conditions. The following inspection periods are based on average duty with single shift operation (20~25% on time and 100~150 times/hour starts) under normal environmental condition.

If the hoist is used in heavier applications or under adverse environmental conditions, it should be inspected more frequently.

CAUTION

Do not operate hoist until all deficiencies are corrected.

5.2 Inspection

(a) Daily inspection

Inspect the following items daily before operating hoist.

1. Check pushbutton station, brake and limit switch for improper operation.
2. Inspect the hook to ensure that no abnormal wear exists on the sling section and the hook is not bent to open excessively. Fig. 3 shows standard dimensions of the mouth opening.

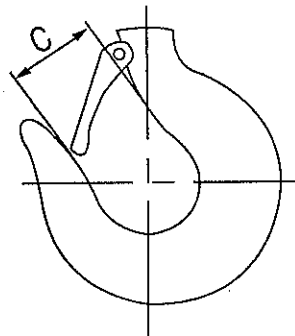

CAP.	0.5T	1T	2T	3T	5T
NORMAL "C"	37.5	37.5	42	43	56

Figure 3 Hook Dimensions

3. Make sure that bottom hook swivels freely.
4. Check link chain for wear, twist or distortion.
5. Check for damaged or improperly working hook latch.

NOTE: If bent or twisted hook is observed, other load bearing components of hoist or trolley shall be inspected, because bent or twisted hooks indicate over loading or abuse of the unit.

CAUTION

Do not operate the hoist if it is functioning improperly or damage is noted.

(b) Monthly inspection

Inspect the following items at 30-day intervals.

1. All items under daily inspection.
2. Chain: If chain binds jumps or is noisy, check for cleanliness and proper lubrication. If trouble persists, inspect chain for wear and elongation. (See Fig. 4 and 5)

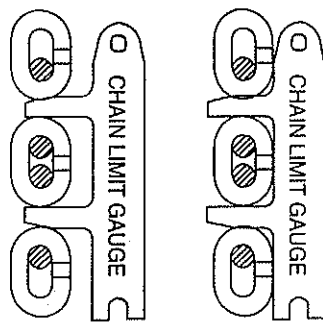

Usable Unusable

Figure 4 Measuring the Pitch

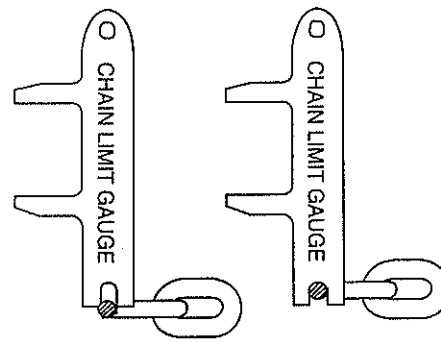

Usable Unusable

Figure 5 Measuring the Link Stock

3. Hooks: check for cracks or deformations. Replace hook if the mouth opening is in excess of normal hook opening or twists from normal plane of hook.
4. Load and idler sheaves: sheaves which are worn should be replaced. Worn sheave can greatly reduce the life of load chain.
5. Electric parts: check for signs of pitting or any deterioration of controls, limit switch and pushbutton.
6. Check for loose bolts, screw and nuts.
7. Brake gap: Check the brake gap. When the brake gap has over its limit 0,3 to 1 mm, brake gap adjustment should be necessary, according to Fig. 6.

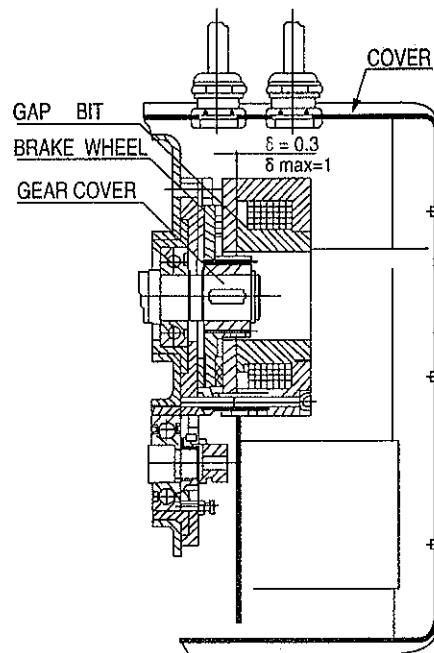

Figure 6 Check to Measure Brake Gap

NOTE:

When measuring the brake gap, the magnetic field should be pressed against the brake support.

When adjusting the brake gap, turn off the power supply and unload the electric chain hoist.

(c) Annual inspection

Inspect the following items annually.

1. Check all items under daily and monthly inspection.
2. Check hooks for cracks by means of magnetic particle test or other suitable crack detecting test.
3. Inspect supporting structure and trolleys (if used) for continued ability to support the imposed loads.

4. Check brake.
5. Check the quantity of the lubricant grease in the gear case.

NOTE: It is recommended that annual inspection be done by an authorized Seagull repair and its record be kept for future use.

5.3 MAINTENANCE

(a) Lubricant

The gear case of this hoist is packed with 500g (around 1/2 Lbs) of molybdenum disulfide grease for use under high pressure.

When gear case is opened, degrease with lubricant which contain molybdenum for high pressure use.

The following table shows recommended standard frequency of lubrication for each part.

Component	Type of lubricant	Type of Service and Frequency of Lubrication		
		Heavy	Normal	Infrequent
Load chain	#1 Multi-purpose lithium base grease	Daily	Weekly	Monthly
Gearing	#1 Multi-purpose lithium base grease	As periodic inspection		
Limit switch shaft	General purpose spray lubricant	Monthly	Yearly	Yearly
Lower hook bearing	SAE 30 gear or motor oil	Weekly	Monthly	Yearly
Top hook	SAE 30 gear or motor oil	Monthly	Yearly	Yearly
Idler sheave bearing	#1 Multi-purpose lithium base grease	As periodic inspection		

(b) Wiring and terminal

See all connections are tight. Terminals are to be securely crimped to wires and insulation sound.

Replace terminals or wire if necessary.

Replace the lock washer if it is missing.

(c) Load chain

Carefully inspect the chain for wear between the links in the section of chain that most often passes over the sheaves. Check several links, as wear is seldom even from on link to another. The chain should be replaced if wear has increased the specified gauge length the limits. Chain gauge is attached to each unit for convenience. (See Figure 7 and 5)

If chain gauge is missing, measure the gauge length by caliper.

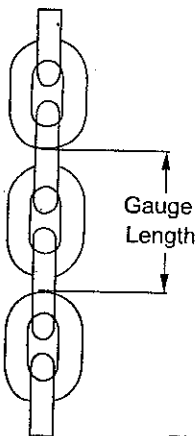

Dia of chain	Max Gauge Length Allowable Used Chain
Ø 7.1mm	49mm

Figure 7 Gauge Length

NOTE: The gauge length should be checked with a load on the hook.

5.4 Function Testing

After repair of hoist, test with a light load for proper function. Make sure that all device mechanism operate properly with a light load, then apply 100% of rated capacity.

Check brake operation.

6. TROUBLE SHOOTING

6.1 Procedures

It is quite difficult to give general instructions which will cover all possible cases. Here are listed only extremely common examples.

If any trouble which is not listed here occurs, inform your nearest local representative.

1. HOOK DOES NOT RESPOND TO PUSHBUTTON

Possible Cause	Remedy
(a) No voltage at hoist-main line or branch circuit open; fuse blown or circuit breaker tripped.	(a) Close switch, replace fuse or reset breaker.
(b) Open control circuit Open or shorted winding in the trans; reversing controller coil or speed selecting relay coil; loose connection or broken wire in circuit; mechanical binding in contactor relay; control station (push button) contacts not closing or opening	(b) Electrical continuity and repair or replace defective part.
(c) Brake not opening	(c) Check solenoid lead. Replace the solenoid if necessary.
(d) Wrong voltage or frequency.	(d) Be sure all electrical characteristics are as listed on the hoist nameplate.
(e) Excessive overload.	(e) Reduce loading to the capacity of hoist.
(f) Error Phase	(f) Replace the connect phase

2. HOOK MOVES IN WRONG DIRECTION

Possible Cause	Remedy
(a) Wrong connections reversed at either the control station or terminal block.	(a) Check connections with the wiring diagram.
(b) Failure of the Direction Switch (motor reversing switch) to effect dynamic braking at the time of reversal.	(b) Check connections to switch. Replace a damaged switch or faulty capacitor.

3. HOOK LOWERS BUT WILL NOT RAISE

Possible Cause	Remedy
(a) Excessive load.	(a) Reduce load to the capacity of the hoist.
(b) Open hoisting circuit-open or shorted wiring in reversing contactor coil; loose connection or broken wire in circuit; control station contacts not making; Upper limit switch contacts open.	(b) Check the switch connections and contacts for sticking or damage. Check centrifugal mechanism for loose or damaged components. Replace defective part.
(c) Start Capacitor damage	(c) Replace the running capacitor

4. HOOK RAISES BUT WILL NOT LOWER

Possible Cause	Remedy
(a) Open lowering circuit-open or shorted wiring in reversing contactor coil; loose connection or broken wire circuit; control station contacts not making; Upper limit switch contacts open.	(a) Check the switch connection and actuator and contacts for sticking or damage. Check centrifugal mechanism for loose or damaged components. Replace defective part.

5. HOOK DOES NOT STOP PROMPTLY

Possible Cause	Remedy
(a) Brake slipping.	(a) Check brake mechanism.
(b) Excessive load.	(b) Reduce loading to the capacity of hoist.
(c) Wrong wiring of brake leads.	(c) Check connectors with wiring diagram.

6. HOIST OPERATES SLUGGISHLY

Possible Cause	Remedy
(a) Excessive load.	(a) Reduce loading to the capacity of hoist.
(b) Low voltage.	(b) Correct low voltage condition.
(c) Brake dragging.	(c) Check brake mechanism.
(d) Running capacitor damage	(d) Replace the damaged running capacitor.

7. MOTOR OVERHEATS

Possible Cause	Remedy
(a) Excessive load.	(a) Reduce load to the capacity of the hoist.
(b) Low voltage.	(b) Correct low voltage condition.
(c) Wrong wiring of brake leads.	(c) Above an ambient temperature of 40°C (104°F), the frequency of hoist operation must be limited to avoid overheating of motor. Special provision should be made to ventilate the space or shield the hoist from radiation.
(d) Frequent starting or reversing.	(d) Avoid excessive inching, jogging or plugging. This type of operation drastically shortens the motor and causes excessive brake wear.
(d) Brake dragging.	(e) See item 6-(c).

8. HOOK FAILS TO STOP AT EITHER OR BOTH ENDS OF TRAVEL

Possible Cause	Remedy
(a) Limit switches not opening circuit.	(a) Check switch connections. Electrical continuity and mechanical operation. Check switch adjustment.

9. HOIST IS NOISY

Possible Cause	Remedy
(a) Noisy gears-excessive wear of gear; insufficient quantity of grease.	(a) Check gears. Replace gear or degrease.
(b) Higher voltage (single phase model)-pulsation of single phase motor become bigger.	(b) Check voltage at power source.

CAUTION

1. Ensure that the new chain is straightened and not twisted.
2. Make sure the new chain is the same size with the old one.

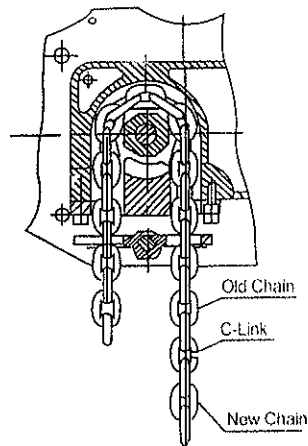

Fig. 10 Engaging the New Chain

CAUTION

It is recommended that this chain replacement be done only by an authorized Seagull Repair Shop.

8. LIST OF REPAIR PARTS

Item No.	Part Name	Quantity
1	Nameplate	1
2	Cover	1
3	Hex bolt	12
4	Motor cover packing	2
5	Motor subassembly	1
6	Motor side plate	1
7	Bearing 6108	1
8	Sprocket wheel	1
9	Bearing 6109	1
10	Sprocket wheel box	1
11	Load chain baffle	1
12	Conduit	2
13	Top hook set subassembly	1
14	Gear side plate	1
15	Spline gear	1
16	Guide chain frame	1
17	Driving gear shaft	1
18	Bearing 6303	1
19	Gear pin	1
20	Clutch set	1

21	Driven gear subassembly	1
22	Spacer	1
23	Spring disk	1
24	Spring seat	1
25	Adjust nut	1
26	Gear case spacer	1
27	Gear case cover	1
28	Bearing seat A	1
29	Bearing seat B	1
30	Bearing 6205	1
31	Bearing 6304	1
32	Linker disc	1
33	Gear cover packing	1
34	Cover	1
35	Bottom hook subassembly	1
36	Load chain	1
37	Spring buffer	2
38	Chain bucket set	1
39	Operating element stopper	1
40	Knighthead	14
41	Shore tube	2
42	Cable hook	1
43	Arrester assembly	1
44	Capacitance start	1
45	Capacitance run	1
46	Jiggle switch subassembly	1
47	Contactor subassembly	1
48	Transformer	1
49	Connection terminal	1
50	Rectifier	1
51	Electric fixing plate	1
52	Cortrol wire	1
53	Pushbutton	1
54	Cable tie-in	2
55	Line wire	1
56	Chain frame subassembly	1

HHXG SERIES ELECTRIC CHAIN HOIST EXPLODED
DRAWING FOR PARTS AND COMPONENTS

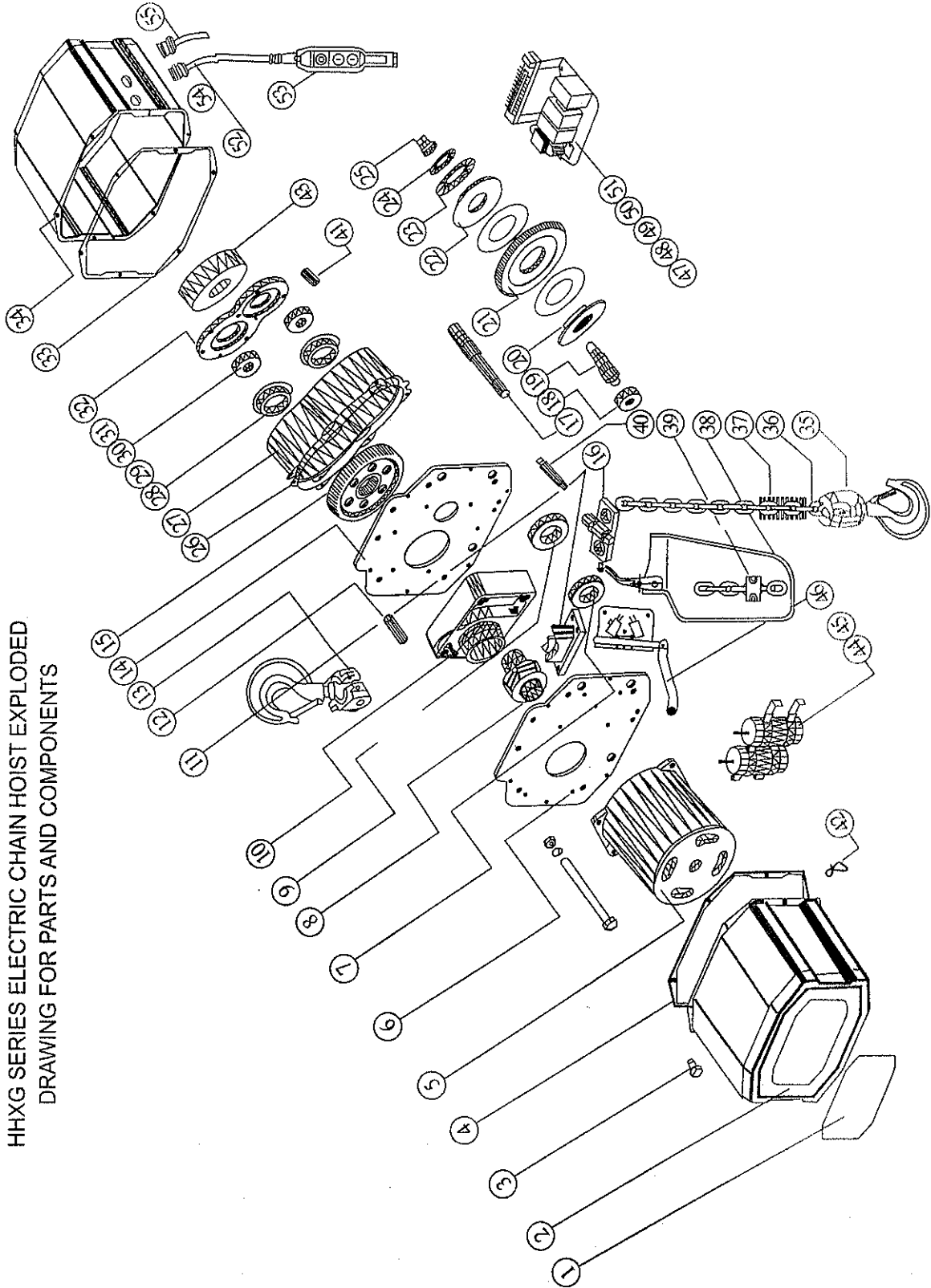

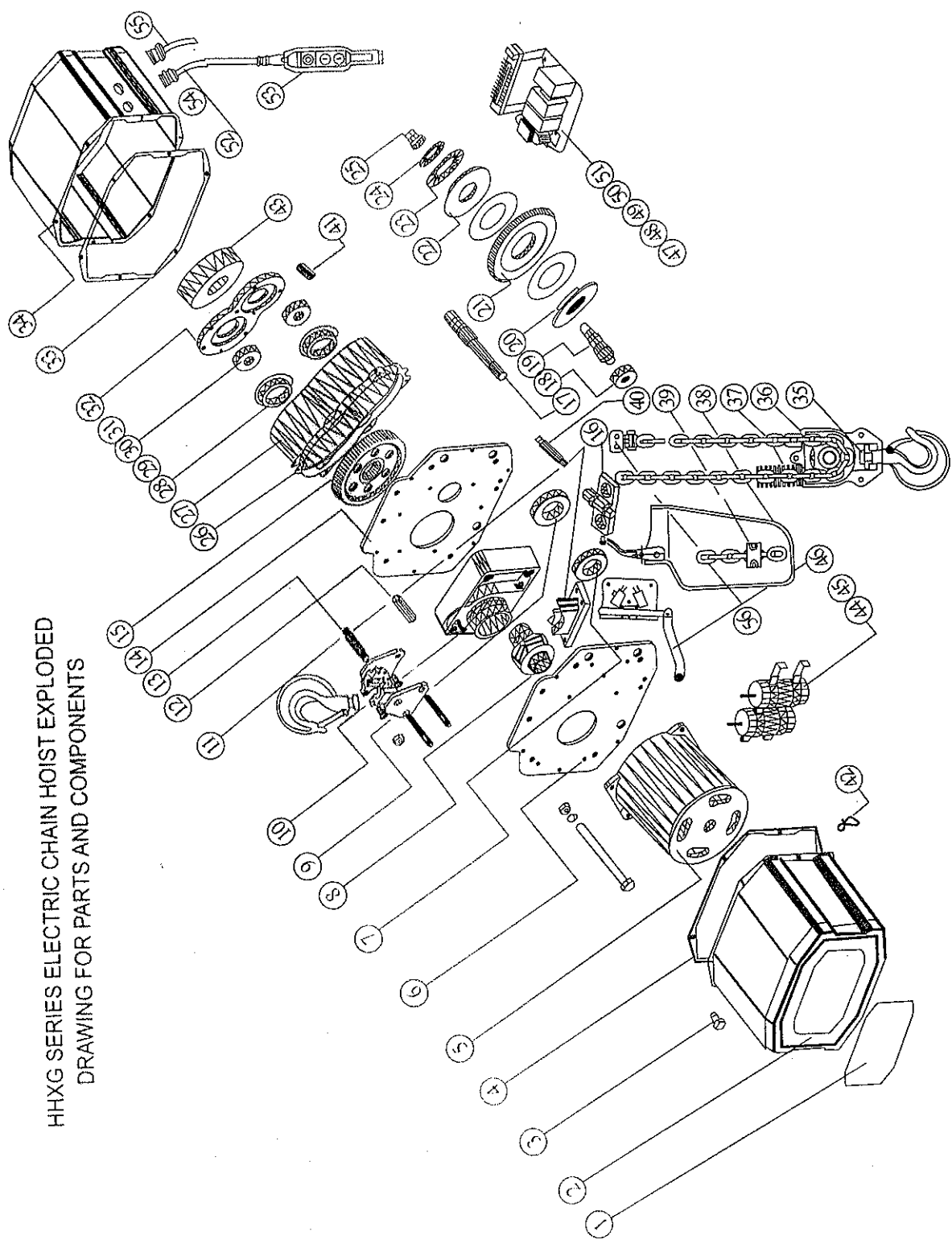

HHXG SERIES ELECTRIC CHAIN HOIST EXPLODED
DRAWING FOR PARTS AND COMPONENTS

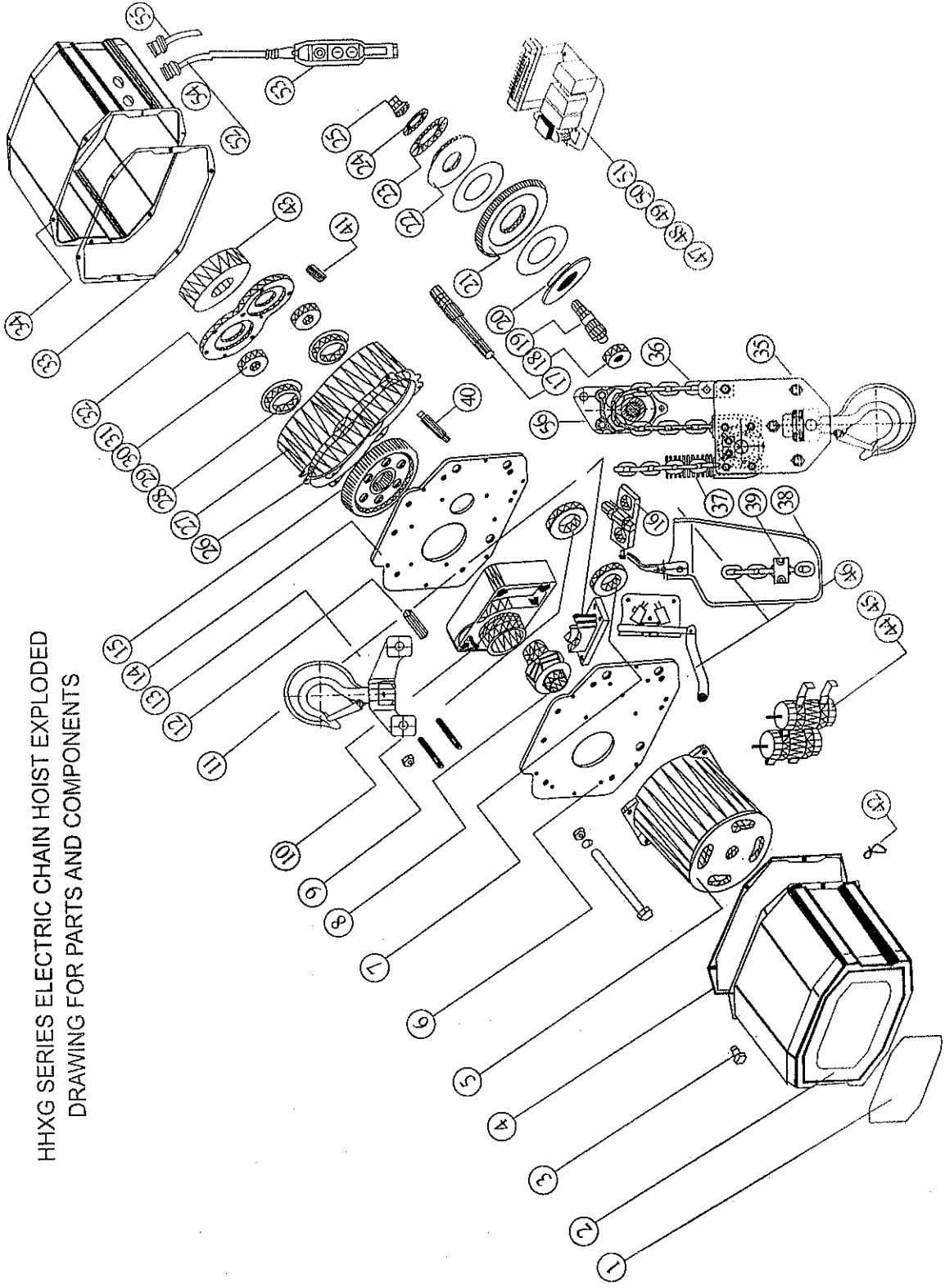

HHXG SERIES ELECTRIC CHAIN HOIST EXPLODED
DRAWING FOR PARTS AND COMPONENTS

HHXG SERIES ELECTRIC CHAIN HOIST EXPLODED
DRAWING FOR PARTS AND COMPONENTS

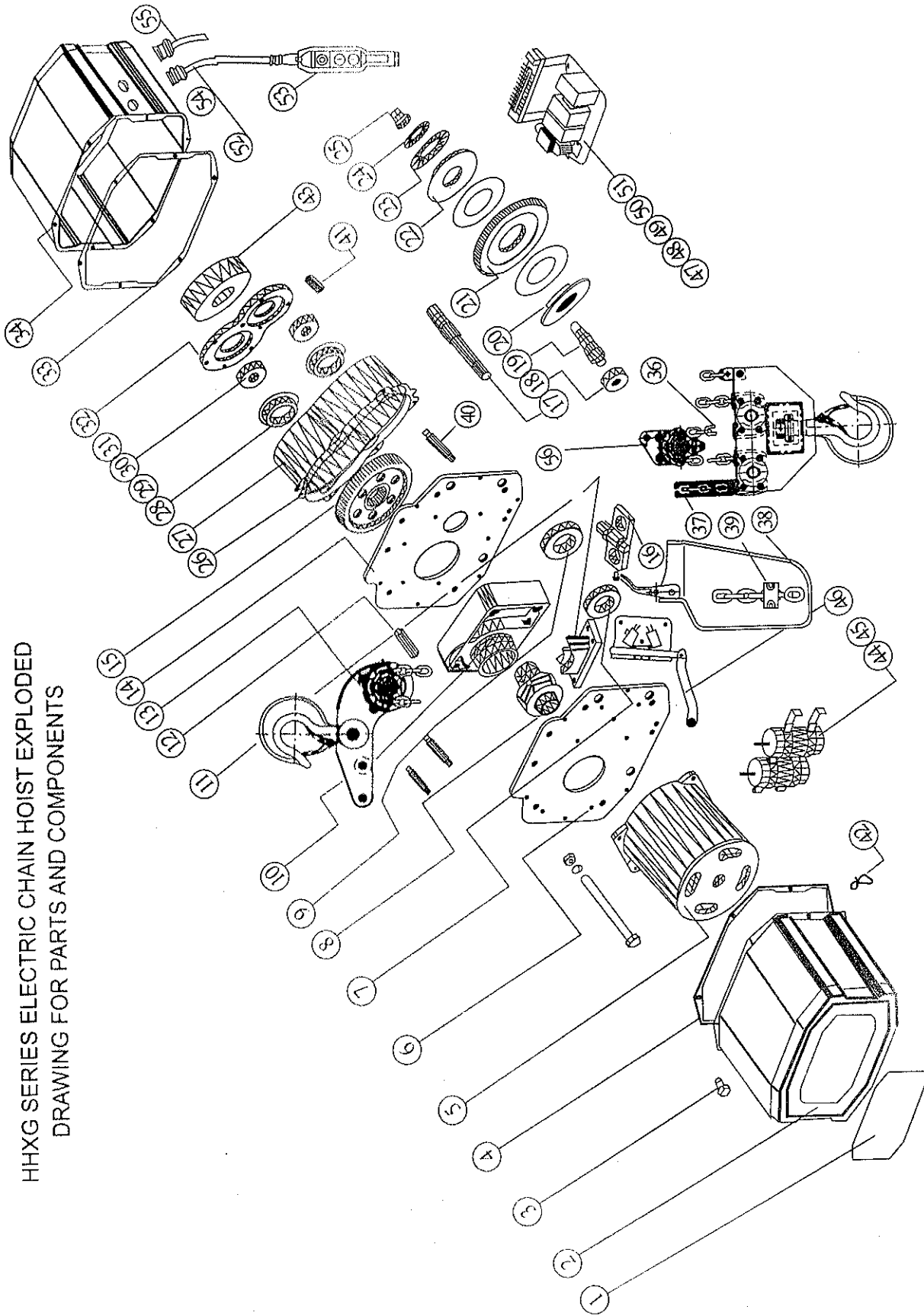

FOR YOUR SAFETY

Please read and follow instruction manual in detail.

- 1.** Do not lift people and never ride the hoisting load.

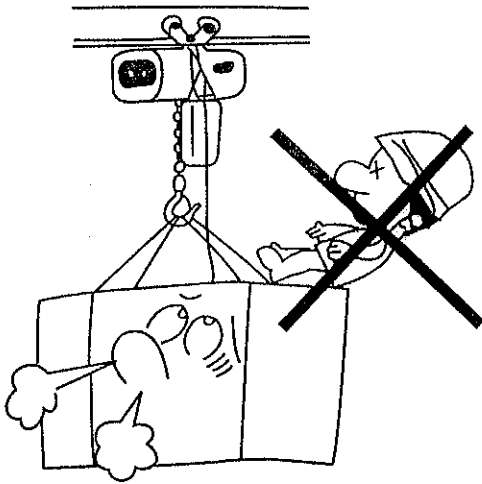

- 2.** Do not lift load over people. Do not shall be under the hoisting load.

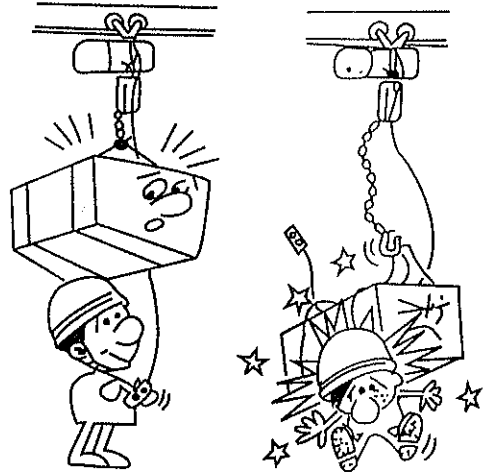

- 3.** Make sure the sling is well balanced. Avoid tip loading, and loading on hook latch.

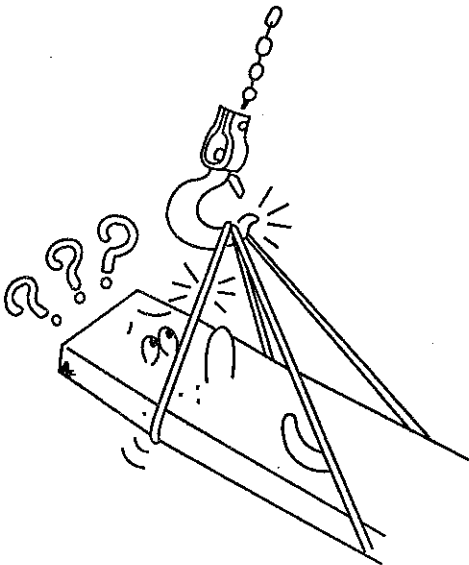

- 4.** Never lift the load over the rated capacity.

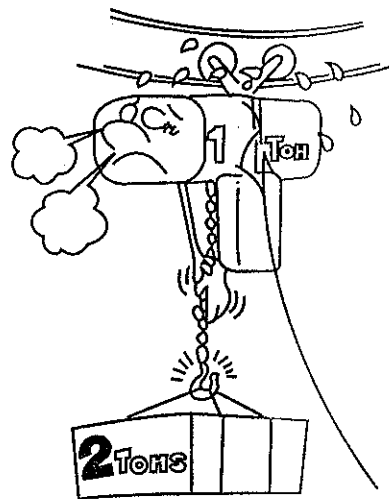

5. Do not operate with kinked, twisted or damaged chain.

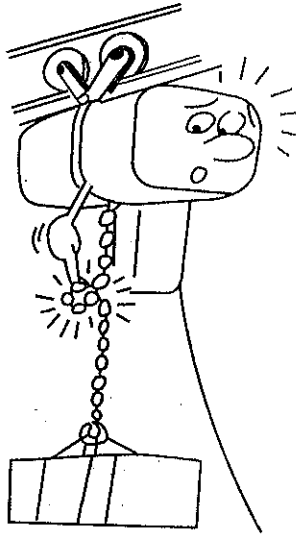

6. Avoid side pull or end pull, and quick reversal operations.

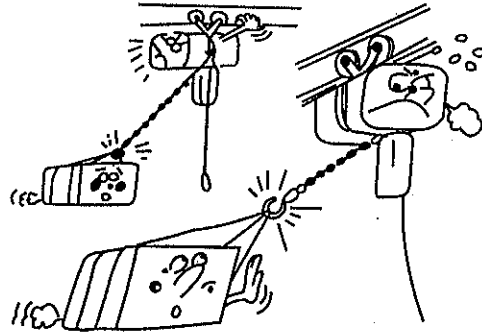

7. Never leave the suspended load unattended.

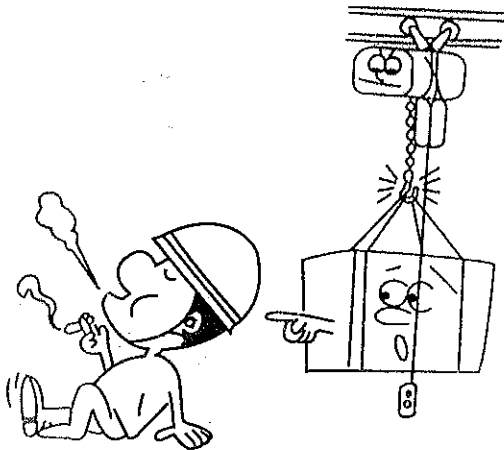

8. Make sure you take up slack slowly.

